

# CYCLONE

## ASSEMBLY AND INSTALLATION INSTRUCTIONS

**S.R. Smith**



### **\*\* CAUTION \*\***

S.R. SMITH CYCLONE SLIDES ARE MANUFACTURED FOR INSTALLATION AND USE ON INGROUND SWIMMING POOLS ONLY. THE CYCLONE IS NEVER TO BE INSTALLED AND USED ON ABOVEGROUND POOLS, ONGROUND POOLS, HOUSEBOATS, BOAT DOCKS, FLOATING DOCKS OR PLATFORMS OR OTHER BODIES OF WATER SUCH AS LAKES, PONDS, RIVERS, ETC.

CORPORATE HEADQUARTERS  
WESTERN SALES AND MANUFACTURING PLANT  
P.O. Box 400 • 1017 SW Berg Parkway  
Canby, Oregon 97013  
Phone: (503) 266-2231 • Fax: (503) 266-4334  
[www.srsmith.com](http://www.srsmith.com)

# Table of Contents

<u>Topic</u>	<u>Page #</u>
Introduction.....	2
Parts List.....	3
Gasket Placement.....	4
Assembly Instructions.....	5
Plumbing Installation.....	6
On-Deck Mounting Instructions.....	7
Manufacturer's Placement Instructions.....	8
Installed Slides' Structural & Installation Checklist.....	10

## INTRODUCTION

The Cyclone slide is designed and manufactured for installation and use on inground swimming pools only. Cyclone slides are NEVER to be installed and used on aboveground pools, onground pools, houseboats, boat docks, floating docks or platforms, or other bodies of water such as lakes, ponds, rivers, etc. Proper and complete assembly, use and supervision is essential for proper operation and to reduce the risk of accident or injury.

### \*\*IMPORTANT\*\*

Check entire boxes and inside all packing materials for parts. Before beginning assembly, read the instructions and identify parts using the figures and parts listed in this document. It is critical that all parts be carefully inspected by the installer prior to installation to ensure that no damage occurred in transit and that a damaged part is not used. Proper installation cannot be overstressed, as an improper installation voids S.R. Smith's warranty and may affect the safety of the user.

**FIG. 1**

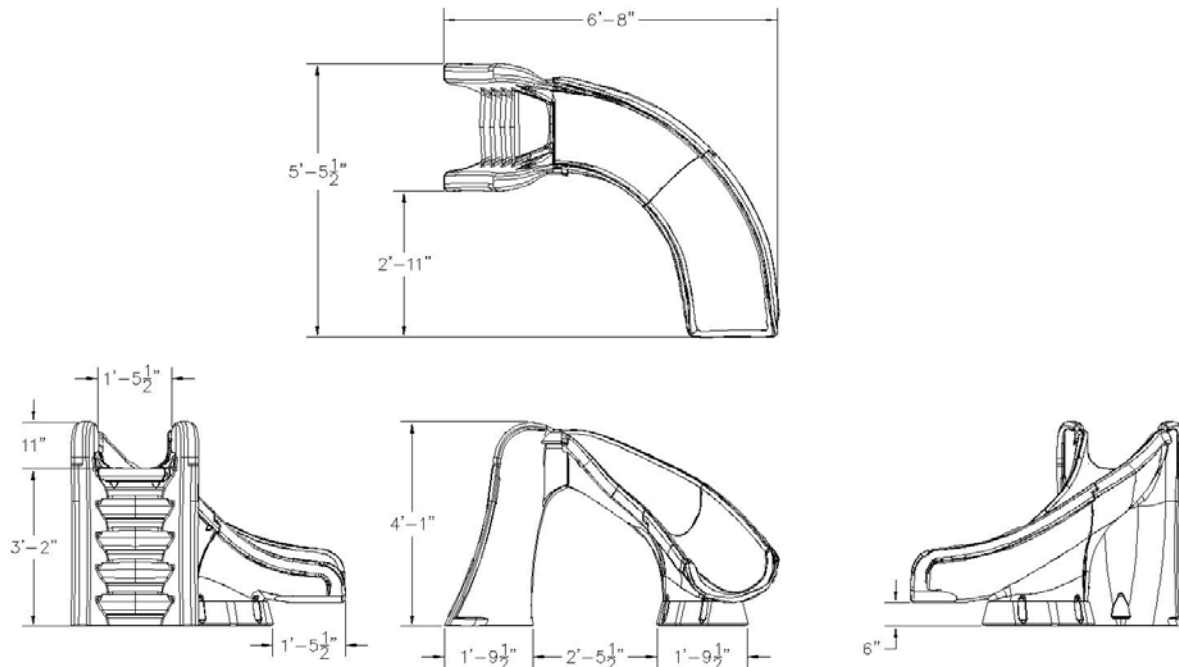

# CYCLONE PARTS LIST

ITEM #	PART #	DESCRIPTION	QTY.
1	5-139	3/8" Hex Nut	2 ea.
2	5-151	3/8" Lock Washer	2 ea.
3	05-14-115	1/2" Lock Washer	7 ea.
4	5-145	3/8" Flat Washer	16 ea.
5	5-245	3/8" x 2-1/2" Lag Screw	10 ea.
6	5-240	3/8" x 3-1/2" Lag Screw	2 ea.
7	5-238	3/8" x 6" Hex Head Cap Screw	2 ea.
8	5-241	1/2"-13 Anchor 5.5" Long w/Nut & Washer	7 ea.
9	05-711	PVC Nipple SCH 80 3/4" x 2"	1 ea.
10	05-712	3/4" FHT x 3/4"FIPT Swivel 90	1 ea.
11	8-531	Gasket	2 ft.
12	5-371	Hose Clip Screw	1 ea.
13	05-713	3/4" Hose Clip	1 ea.



(1)

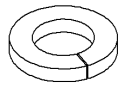

(2)

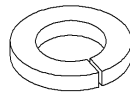

(3)

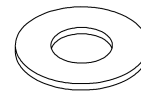

(4)



(5)

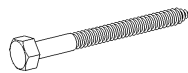

(6)

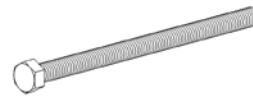

(7)



(8)

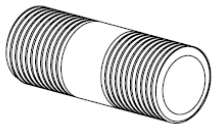

(9)

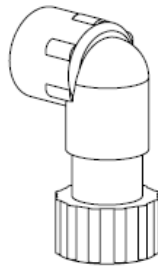

(10)

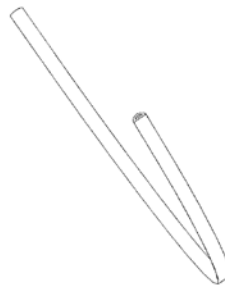

(11)



(12)

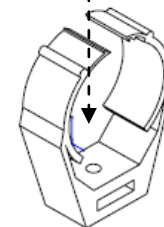

(13)

## Tools Required:

1. Ratchet handle
2. 9/16" deep socket
3. 9/16" wrench
4. 1/2" socket or wrench
5. 1/2" concrete drill bit
6. 1/4" drill bit
7. Phillips screw driver
8. Power drill
9. Lint free rag

**\*\*IMPORTANT\*\***  
**Before assembling sections**  
**Prepare your Cyclone for water**

1. Clean the groove of the top runway section, shown below, with a damp clean rag and dry.
2. Place the gasket.
  - a) Take the 2 feet of gasket provided with your kit and begin to peel back the paper. *Make sure you are not removing the adhesive itself from the gasket.*
  - b) Take the exposed gasket & adhesive and begin at a top edge of the runway section groove.
  - c) While firmly pressing the gasket into the groove, intermittently press and remove more paper, exposing adhesive, until you have used the entire gasket.
  - d) Properly installed, the gasket will extend from one side of the slide to the other and be centered in the groove, front to back.
  - e) Continue to assemble your Cyclone as described on page 5, and ensure the gasket remains in place as you handle the sections.

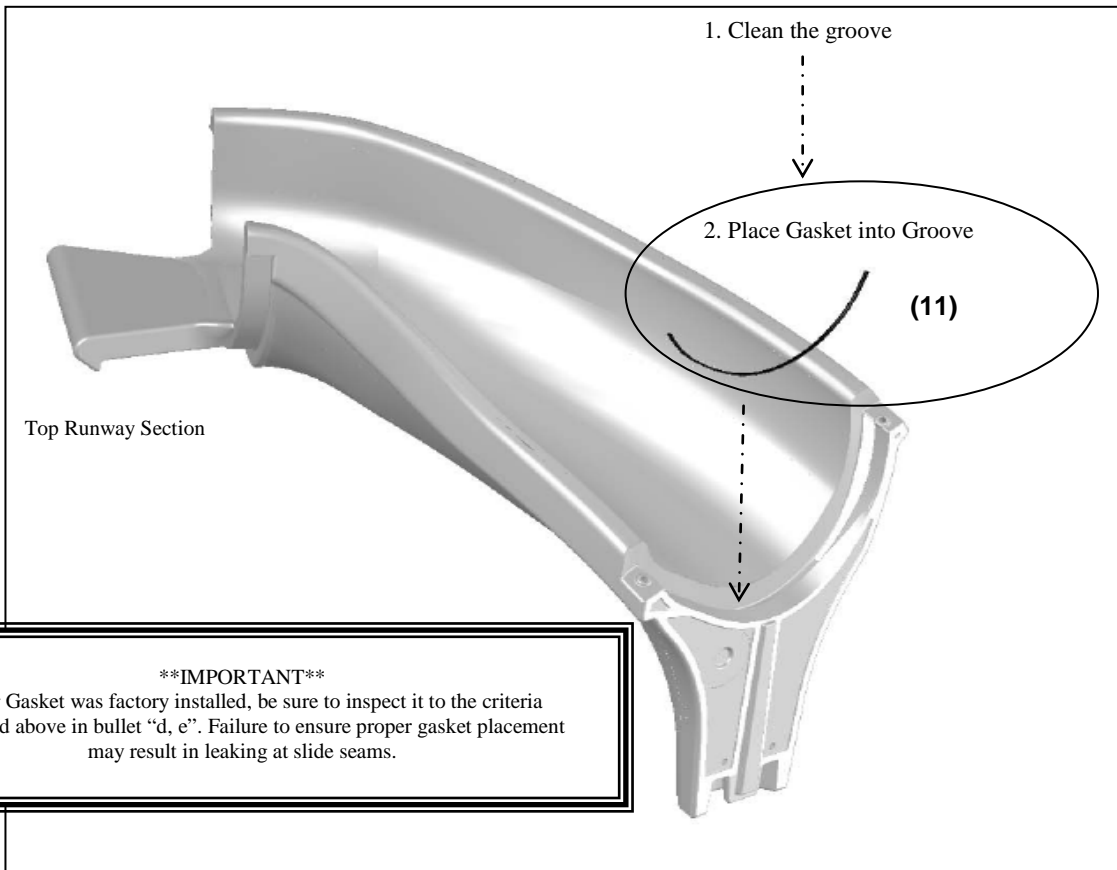

## ASSEMBLY INSTRUCTIONS

1. Place the upper & lower slide runway sections on the ground. Assemble and fasten as shown.

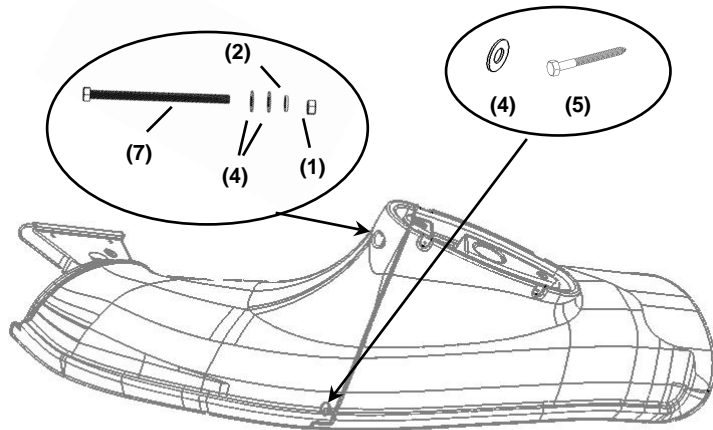

2. a. Attach the pedestal to the upper & lower slide sections as shown in (2) locations.

b. Attach the pedestal as shown in (4) locations. Mark and drill a 1/4" pilot hole in the center of each recess before fastening with the lag screws.

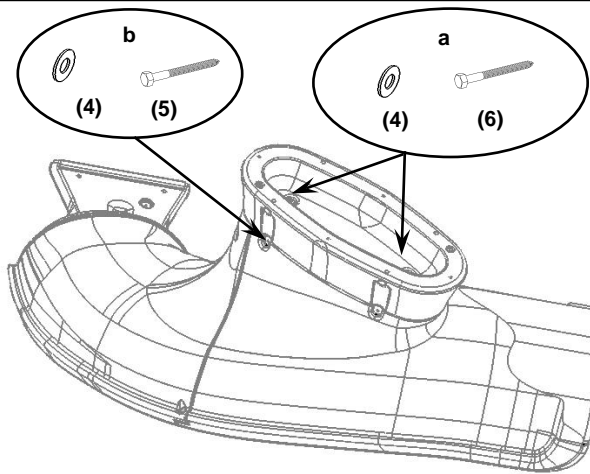

3. Attach the assembled slide runway to the ladder using the hardware shown.

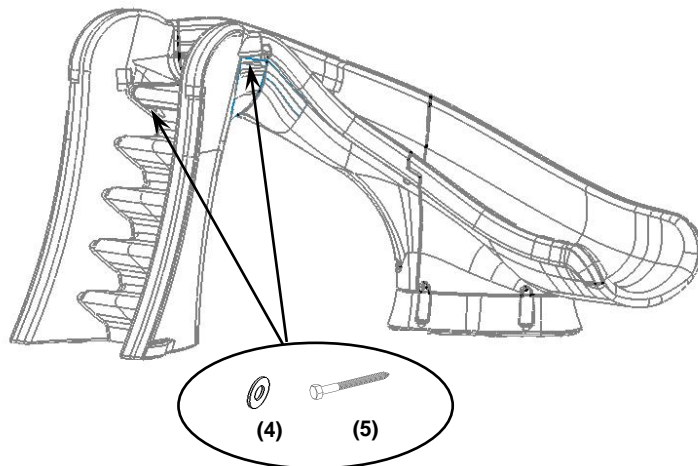

## Plumbing Installation

1. Thread the nipple (9) into swivel (10).
2. Note the angle of the threaded hole in the top runway section.
3. Align the nipple with the hole-angle from the outside of the slide as shown in the top illustration.
4. Insert the nipple into the slide's hole and firmly thread the nipple using the swivel (10) to turn.

**\*\*This action is self sealing and *no* Teflon or Plumbing glue is required\*\***

5. Note the pressure required as you turn the fitting assembly, this is letting you know a tight fit is being formed.

**\*\*The fitting material is harder than the slide material and makes its own threading; that is why it is good to get this right the first time, but not imperative\*\***

6. Turn the fitting assembly (9 & 10) until the swivel (10) comes in contact with the wall of the Cyclone
7. Gently tilt the swivel (10) away from the slide and complete one more turn to ensure a good insertion.
8. Finish turning the swivel (10) with the fitting assembly pointed back toward the bottom of the stairs as shown in the bottom illustration.

**\*\*Threads still showing between the nipple (9) and slide wall after step 8 (above) are better left exposed than over tightening and stripping the hole or scraping the slide wall with the swivel (10)\*\***

9. Place the hose clip in a location where it will support the hose without putting a "kink" into its shape; screw it directly into the slide stairs making sure not to over tighten the screw.

**\*\*The purpose of the clip is to take shock transferred through the hose from sudden jerks\*\***

10. Turn on the water so that it lands in the center of the slide runway and ENJOY!

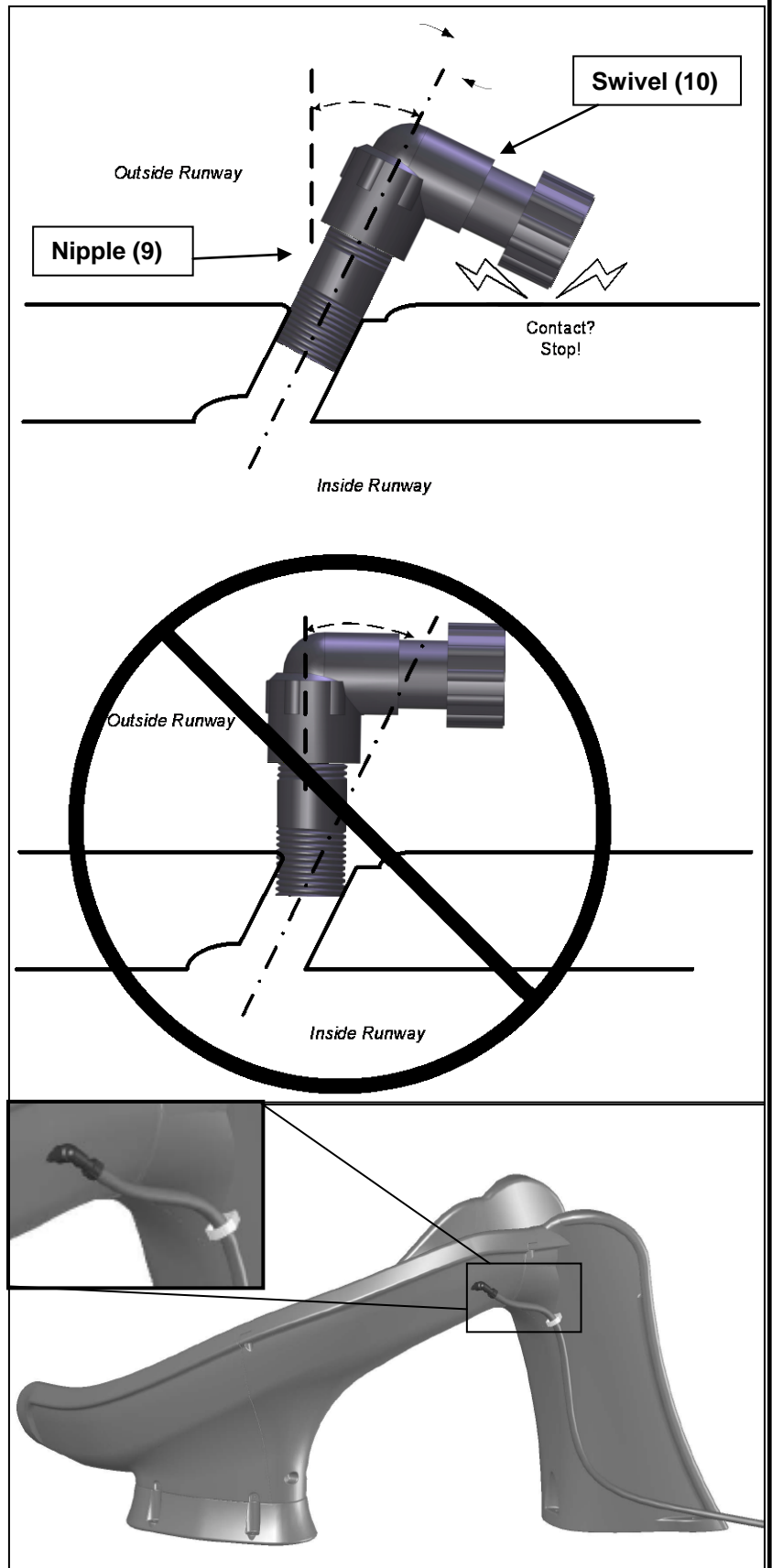

## ON-DECK MOUNTING INSTRUCTIONS

1. Place the assembled slide on the deck relative to the pool wall. Ensure that the exit flume clears any coping. Slide may be angled slightly providing all dimensions are maintained as noted in the **Manufacturer's Placement Instructions** noted in the following section.
2. With the slide in its proper location, center punch or otherwise mark through the (7) mounting holes at the bottom of the ladder and base so that a visible mark is apparent on the concrete.
3. Move the assembled slide aside to facilitate drilling of the anchoring holes.
4. Using a power drill and a 1/2" concrete drill bit, drill the holes to a depth of 4". Use tape or a marking on the drill bit to ensure that the hole for the anchor is drilled to the required depth. Maintain drill hole straight and perpendicular for proper holding strength of anchor stud.

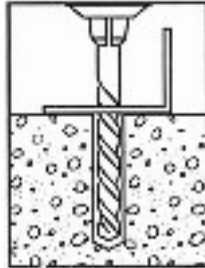

5. Clear the holes of all debris. Assemble anchor with nut and washer so that the top of the nut is flush with the top of the anchor. Move the slide over the holes and insert the anchors. Drive anchor through the slide mounting holes so that nut and washer are flush with the surface material.

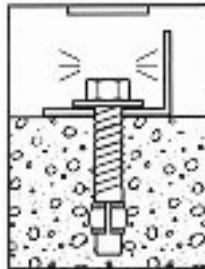

6. Expand anchor by tightening nut 3 to 5 turns. Once anchor is set remove nut and install a lock washer, item # (3), and retighten nut to a torque of 55 ft.-lbs.

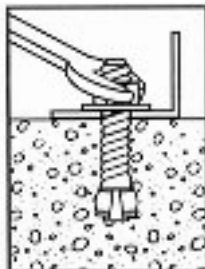

# MANUFACTURER'S PLACEMENT INSTRUCTIONS

1. The critical dimensions for placement of the CYCLONE are as shown in **FIG.'S 2 and 3.**
  - A. The slide exit runway surface shall not exceed twenty inches (20") above the water surface as shown in **FIG. 2.**
  - B. The slide shall be positioned so that all water flowing off the runway exit drops into the pool. The recommended overhang is 4 inches.
  - C. The minimum depth of water below the exit lip of the slide shall be three feet (3') and increase to three feet six inches (3'-6") at Pt. A, which is a distance of four feet six inches (4'-6") from the exit lip of the slide as shown in **FIG. 2.**
  - D. A minimum depth of three feet six inches (3'-6") shall be maintained at a distance of nine feet (9') along the extended centerline of the slide from Pt. A. as shown in **FIG. 2.**

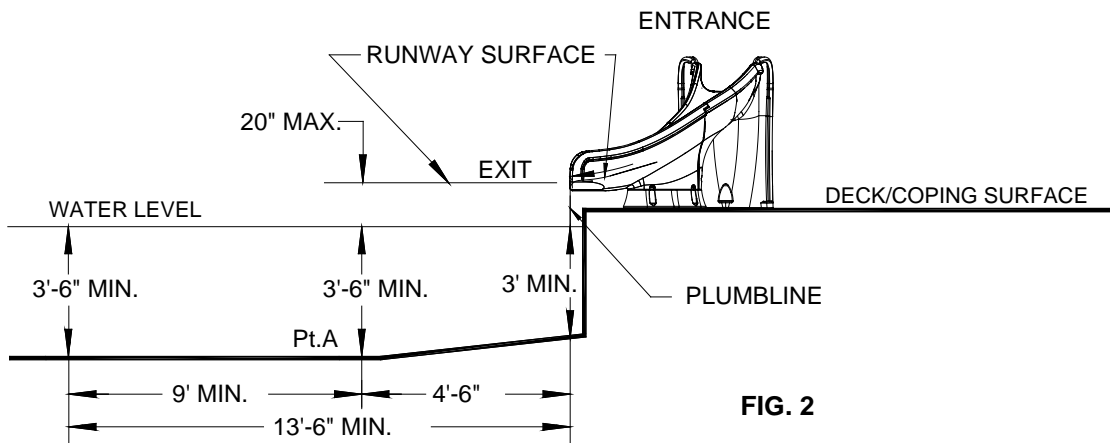

**FIG. 2**

2. A minimum clearance area in front of the slide shall be maintained at all times as follows:
  - A. The minimum clearance distance on either side of the extended centerline of the slide runway shall not be less than three feet six inches (3'-6") at a point no less than two feet six inches (2'-6") from the exit lip of the slide and extending a distance of thirteen feet six inches (13'-6") in front of the slide as shown in **FIG. 3.**
  - B. The minimum clearance area in front of a properly installed diving board on an inground swimming pool is a minimum distance of three feet six inches (3'-6") on either side of the board's centerline as shown in **FIG. 4.** Pt. C extends a minimum distance of "C" from the tip end of the board as shown in **FIG. 4.** The width distance "W" on either side of Pt. C is given in **CHART 1** and shown in **FIG. 4.**

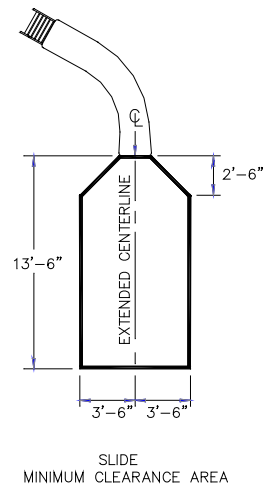

**FIG. 3**



### CHART 1

BOARD MINIMUM CLEARANCE AREA		
POOL TYPE	"C" DIMENSION	"W" DIMENSION
I	14'-6"	5'-0"
II	14'-6"	6'-0"
III	16'-6"	6'-0"
IV	18'-6"	7'-6"
V	21'-0"	7'-6"

See Article 5 contained in ANSI/APSP/ICC-5 2011 STANDARD FOR RESIDENTIAL INGROUND SWIMMING POOLS and refer to FIGURE 3 and Table 1 for Minimum Water Envelope Dimensions AB, BC and Width at Point C.

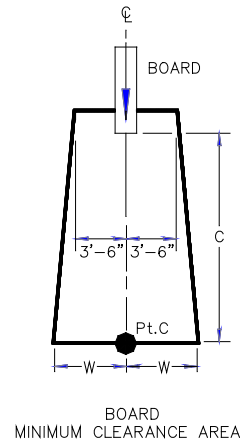

**FIG. 4**

"C" DIMENSION FOR BOARD = AB + BC  
 "W" DIMENSION FOR BOARD = WIDTH AT PT.C

- C. The minimum clearance area of a slide or diving board shall not intersect any coping or rope and float line as shown in **FIG. 5**. The minimum clearance area of a slide or diving board may intersect each other provided that they are not used simultaneously.

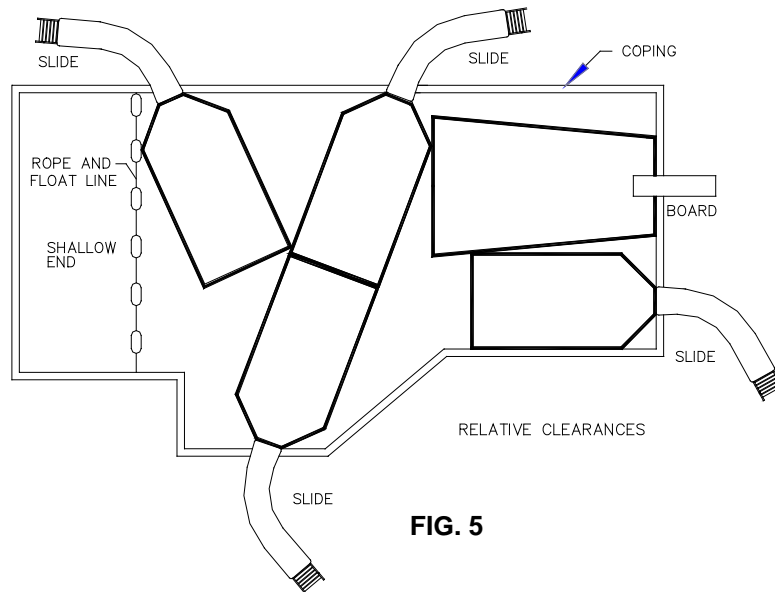

## **INSTALLED CYCLONE STRUCTURAL & INSTALLATION CHECKLIST**

1. Inspect the runway for visible cracks or tears.
2. Inspect the ladder for sharp edges, protrusions, cracks or tears.
3. Inspect all fasteners to make sure they are fully tightened.
4. Inspect the ladder for rigidity and attachment.
5. Measure the following dimensions and compare with the Manufacturer's Placement Instructions on pages 6 and 7.
  - Measure the depth of water in front of the slide exit. (3'-6" min. depth at a distance of 4'-6" from exit end of slide.)
  - Measure the height of the slide runway exit above the water. (20" max.)
  - Measure the distance between the slide centerline and the edge of other pool equipment.
6. Observe the position of the exit of the slide as shown in **FIG.'S 2, 3 and 5** on pages 6 and 7.

### **IMPORTANT**

**PERSONALLY GIVE TO SLIDE OWNER THE CYCLONE OWNER'S MANUAL, THE WARRANTY CARD AND ANSWER ALL QUESTIONS.**